

Article number: 20133B45B302SW
 Description: E+G Two-way Connector
 GN133-B45-B30-2-SW

Measures

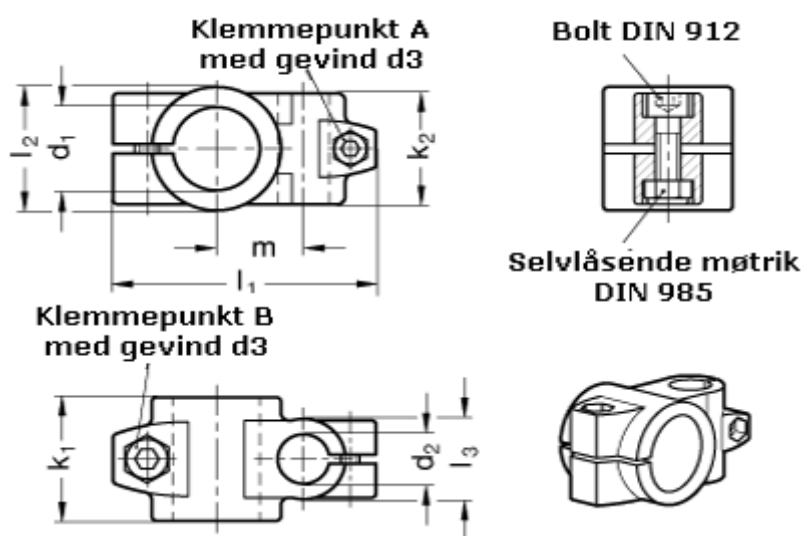

Adjustable clamp lever for d3 = GN 911-M10-55 have to be ordred separately

Adjustable clamp lever for d4 = GN 911-M 8-32 have to be ordred separately

d1 = 45
 d2 = 30
 d3 = M10
 d4 = M 8
 k1 = 65
 k2 = 59

l1 = 122.0

l2 = 65

l3 = 40

m = 45